

# 2 DRAWER NIGHTSTAND

Stock number: 3036-72

Thank you for purchasing this product. Please read the instructions carefully before use to ensure safe and satisfactory operation of this product.



## Pre-assembly preparation

Please ensure instructions are read in full before attempting to assemble this product.

## Necessary Tools :



Please check the pack contents before attempting to assemble this product. A full checklist of components is given in this leaflet. If any components are missing, please contact the retailer from whom you bought this product.

This product takes approximately **15 MINUTES** to assemble with **2 PEOPLE**.

All assembly should be performed on a flat, stable, clean and soft surface.

The fitting pack contains **SMALL ITEMS** which should be **KEPT AWAY FROM YOUNG CHILDREN**.

**IMPORTANT:** Retain these instructions for future reference.

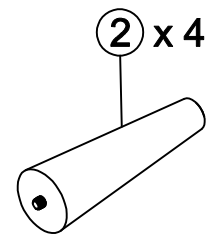
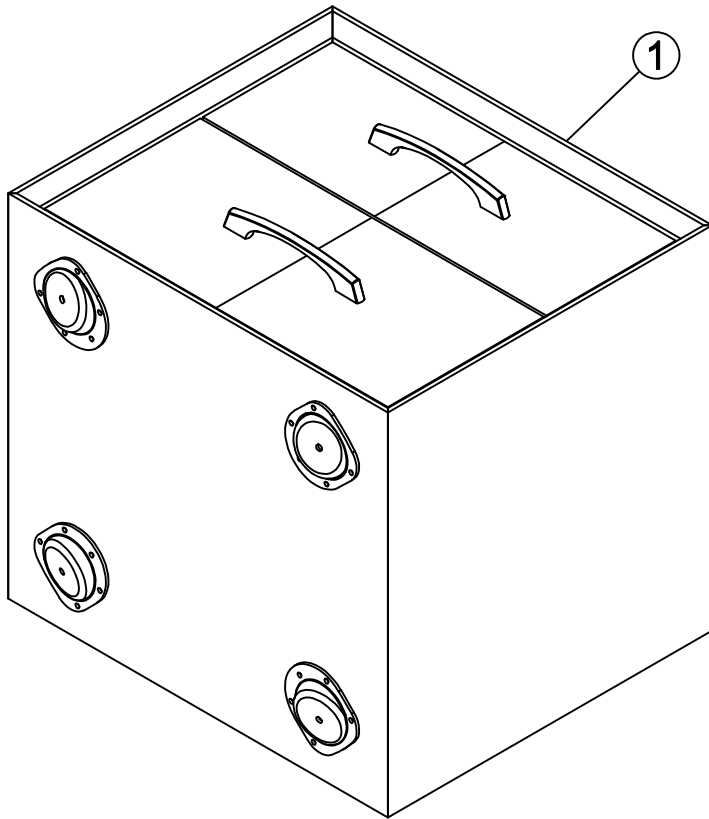

## Fittings and parts checklist

Item	Description	Qty.	Item	Description	Qty.
1	Drawer box unit	x 1	2	Leg	x 4

# Step By Step Assembly Instructions

- Step 1**
- 1.1 : Lay drawer box unit (1) on a flat, stable, clean and soft surface.
  - 1.2 : Screw each legs (2) into the mounting plate on the bottom of drawer box unit (1) as shown. Continue to re-tighten until it is securely fastened. **Repeat this procedure for the remaining legs (2).**
  - 1.3 : Stand the unit upright.

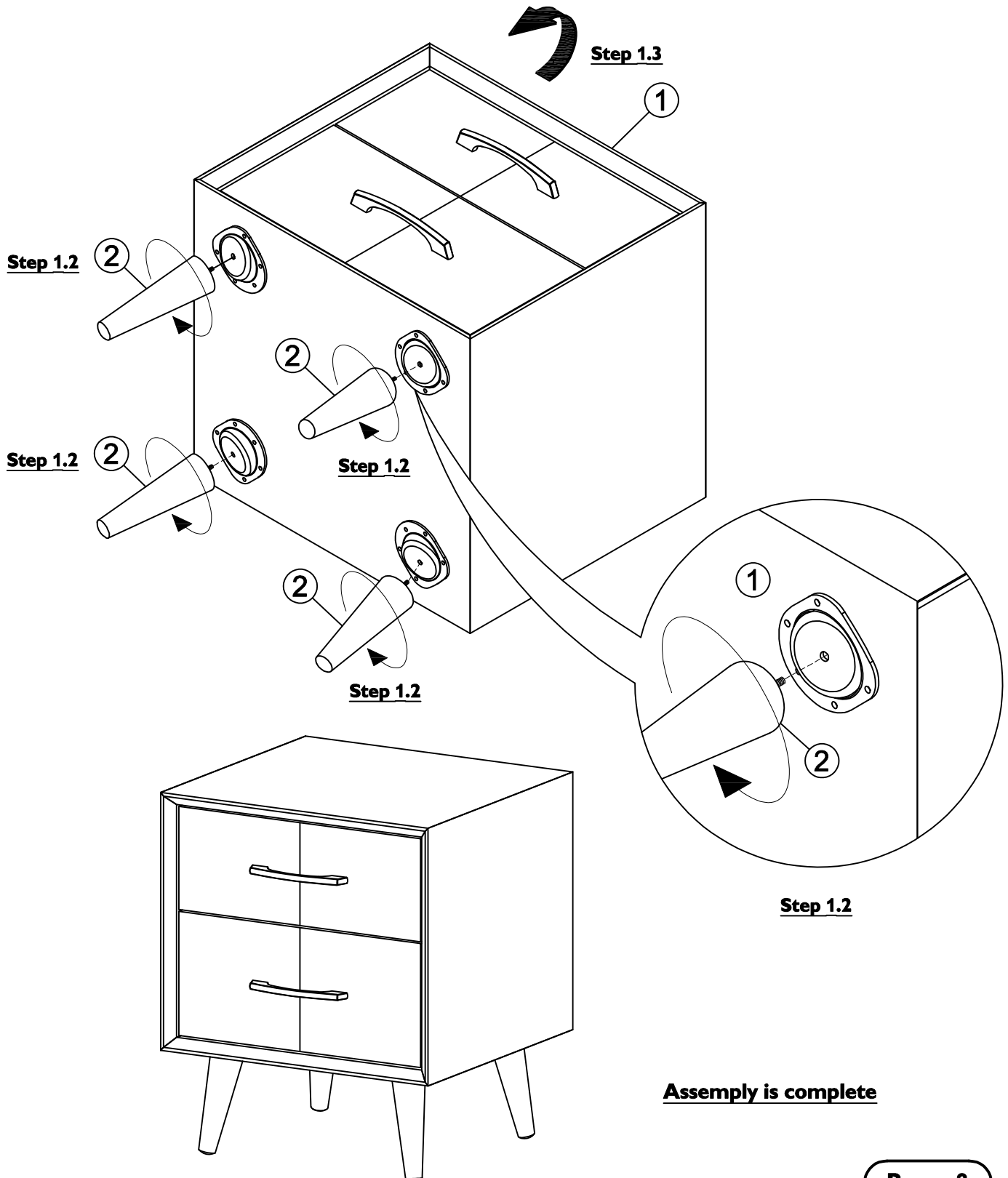

---

# TANDEM RUNNER ADJUSTMENT INSTRUCTION

---

## REMOVE

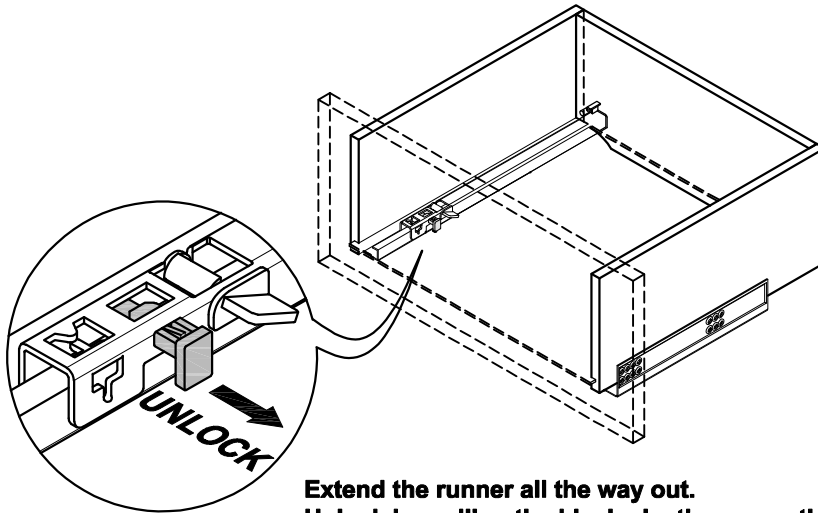

Extend the runner all the way out.  
Unlock by pulling the black plastic peg on the runner out.

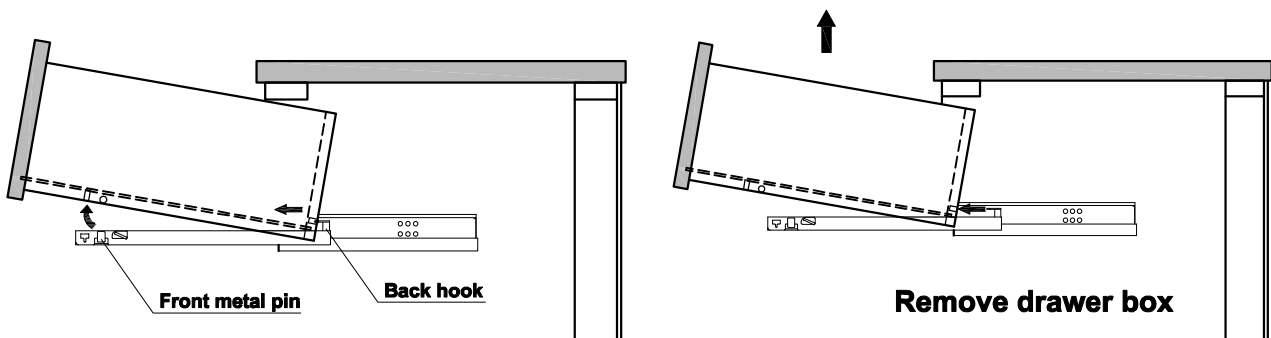

Hold both runners with both of your hands.  
Carefully lift the drawer front up from the front metal pin, then slide forward to remove from back hooks.

---

## VERTICAL ADJUSTMENT ( $\pm 2.5$ mm)

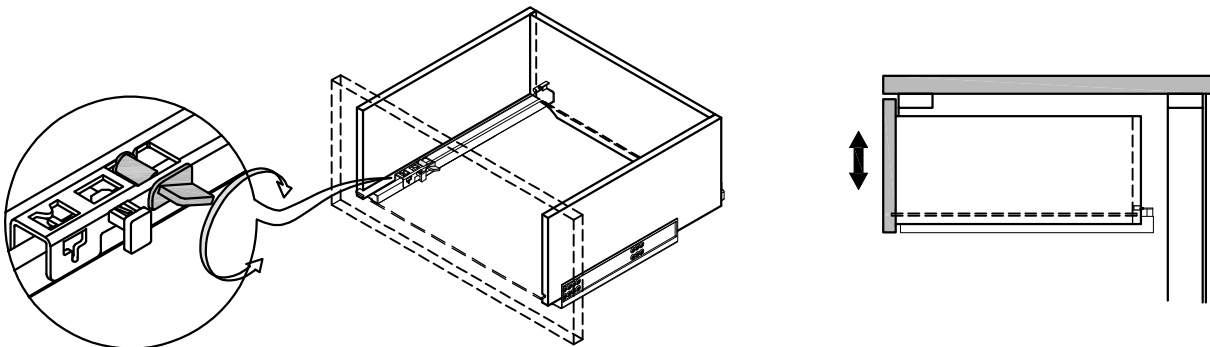

# TANDEM RUNNER ADJUSTMENT INSTRUCTION

## ASSEMBLE

Back hook

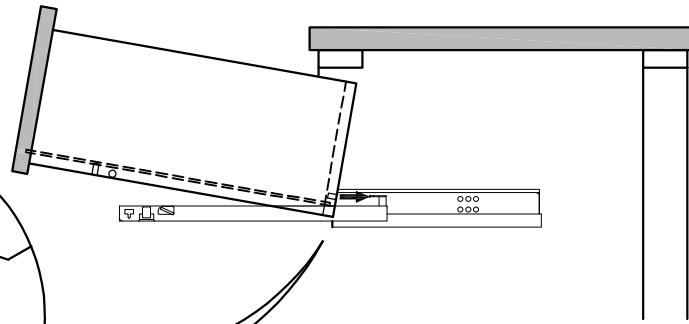
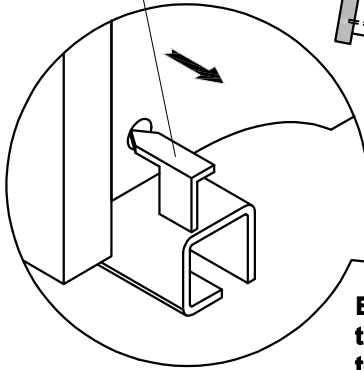

Extend the runner all the way out. Put the drawer onto them then hold both the runners with your hands, lift the drawer up with your thumbs and push to hook the drawer at the end of the runner.

Hole / Front metal pin

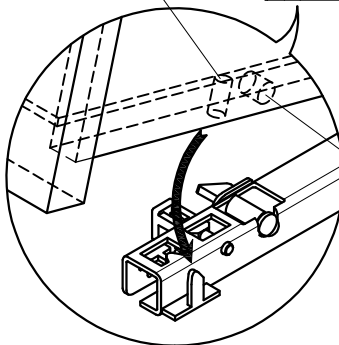

Hole / plastic peg

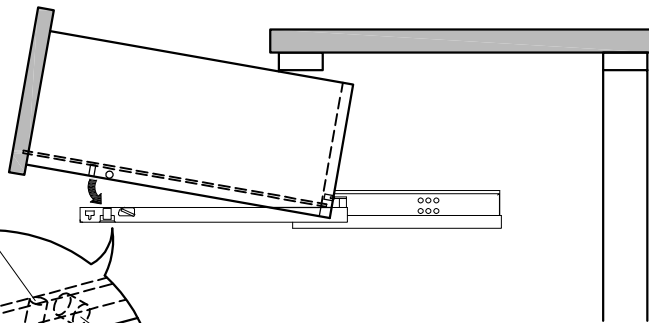

Once the back hook is connected gently lower the drawer onto the front metal pin.

Black plastic peg

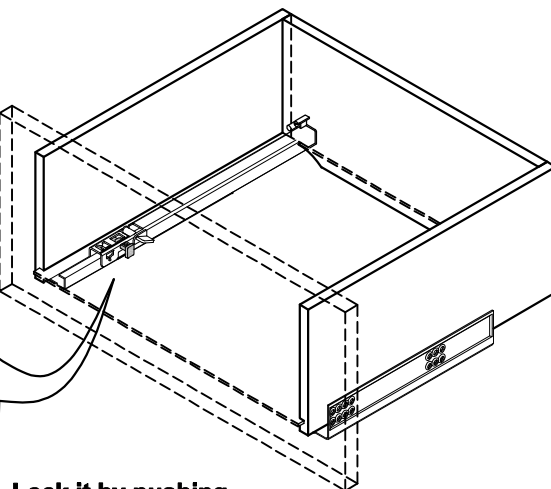
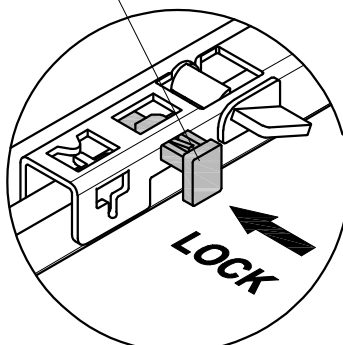

Lock it by pushing the black plastic peg on the runner in.

---

# GENERAL CARE FOR FURNITURE

(Please keep these guidelines for future reference)

## **Furniture containing primarily wood:**

Wood displays different grain patterns depending on which way they are cut - for example, the 'medullary ray' which can appear on oak furniture is a mark of good quality timber - these are just characteristics of the natural beauty of the wood. Some furniture is also deliberately aged and rustic. Wood veneers also allow distinctive patterns to be created on some surfaces, such as table tops and drawer fronts by the way slivers are arranged. All timber and veneer surfaces will change colour and mellow over time. New furniture will initially vary in shade from items that have been previously purchased.

### **1. Do not use abrasive cleaner or harsh detergent as this can damage the surface of the furniture**

- Do not use abrasive detergents or powders. Dust with a clean, lint free cloth.
- To remove normal stains or dirt use a mild detergent or non-abrasive cleaner diluted with warm water. (Immediately dry completely with clean soft cloth).
- Frequent dusting will remove abrasive build up, which can damage a finish over time.
- Spray polishes are best avoided as they contain silicones which may spoil the furniture's surface when building up over time.

### **2. Do not expose your furniture to direct sunlight.**

- Excessive exposure to sunlight can cause fading of your furniture.
- Ornaments placed on the furniture surface should be periodically moved to avoid shading.

#### **Extendable table warning:**

Extendable dining tables should be left extended for the first few months to avoid an uneven appearance.

### **3. Never place household heating appliances or hot objects directly on any furniture surface.**

- Always place a heat resistant coaster between your furniture and a hot object to protect your furniture.

### **4. Do not place your furniture near a heater, heat, dampness or moisture generating appliance.**

- Extreme temperature and humidity changes can cause cracking and splitting.
- Some movement may be expected depending on environmental conditions.
- If the air is dry, some cracks may appear due to shrinkage.
- Our furniture will endure most temperatures in the home but it is best to avoid placing furniture next to heat sources such as radiators or fires.

### **5. Do not place rubber, cork, vinyl or plastic materials on the wood finish as chemicals within may react with the finish if left in contact for an extended period of time.**

### **6. Do not expose your furniture to any liquids.**

- All liquids should be wiped up immediately with a soft, slightly damp cloth in the direction of the wood grain. If sticky liquid residues do occur, they may be removed with a dilute solution of warm soapy water followed by a clean, damp sponge. The area should then be wiped immediately with a clean, soft white cloth until completely dry.
- Nail polish remover, hairspray, perfume, potpourri & any other products that contains solvents can damage surface; wood & upholstery finishes.

### **7. Please do not strike, hit or stand on furniture.**

- Furniture is designed and built for its intended purpose.
- When writing, use a mat to protect the table or desk surface.

### **8. When moving furniture, please lift, do not drag. Protect the surface and corners from knocks & scratches.**

- Take care when handling. Obtain assistance as necessary.
- Once in place make sure it stands level to ensure smooth opening of the doors and running of the drawers.

#### **Chair warning:**

Never lean back and tilt the chair. Ensure the chair is always placed firmly on the ground.

### **9. Furniture containing metal.**

- **NEVER** use an abrasive cleaner or scourer as this will scratch the finish - use a damp cloth with either washing up liquid or soft soap.
- For fingerprints and smears use soap and warm water. Carefully sponge with a solution of mild soap and water. Rinse thoroughly afterwards with warm water. Wipe dry with a clean soft cloth. **Cleaning with chloride-containing detergents must be avoided.**

### **10. Furniture containing glass.**

- Do not use abrasive cleaners to clean glass surface, use a damp cloth with either washing up liquid or soft soap.
- Do not place a heavy object on the glass surface. Do not strike the glass with a sharp object.
- Do not place felt with glue, cork or plastic dots between glass & finished surface since these items can react with a finish.

### **11. Furniture containing High Pressure Laminate.**

- This material is both durable and strong and therefore more resistant to scratches, impact, and abrasion. The surface is resistant to water.

### **12. Furniture containing upholstery**

- The upholstery should not be exposed for long periods to direct sunlight as this may cause fading and deterioration of the cover material.
- Protect from exposure to sources of heat such as radiators or open flames.
- It is recommended to give upholstery a frequent vacuuming or light brushing.
- It is very important to rub very gently to avoid colour change. This proper cleaning will prevent build-up of dust, soil and oils which can be damaging to the cover material.
- In the event of spillage it is imperative to act quickly. Carefully soak up any excess liquid, ideally using the edge of a white paper towel, then dab gently with a fresh towel taking care to avoid soaking in or spreading of the remaining liquid.

### **13. Any assembly required should follow the sequence of steps in the Assembly Instruction Sheet.**

- Please retain assembly instructions and hardware for future reference and use.
- Periodically check all fixings to ensure none have come loose. Re-tighten when necessary.
- Furniture can be dangerous if incorrectly assembled. Assembly should be carried out by a competent person(s). No liability will be accepted from damage or injury caused by incorrectly installed or assembled furniture.

### **14. If the furniture is dented or scratched at any time during use, this can usually be repaired by a qualified technician: Please contact your retailer.**

**WITH PROPER CARE, THIS FURNITURE WILL GIVE YOU MANY YEARS OF USE**

**Page : 6**