

HAMPSTEAD 2+2 DRAWER CHEST

Stock Number: 8005-74

Thank you for purchasing this product. Please read the instructions carefully before use to ensure safe and satisfactory operation of this product.

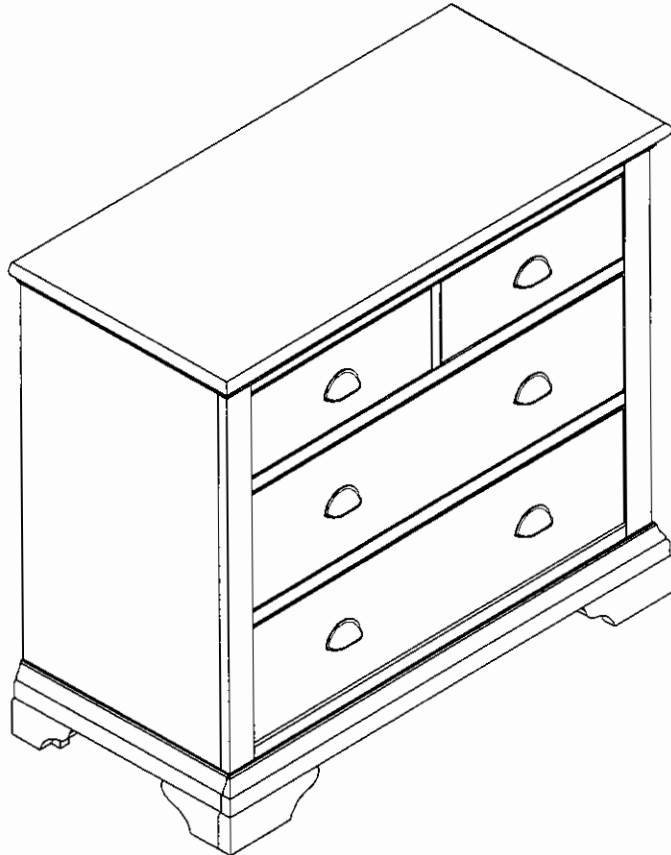

Care and Maintenance

Wood Furniture





Wood displays different grain patterns depending on which way they are cut - for example, the 'medullary ray' which can appear on oak furniture is a mark of good quality timber - these are just characteristics of the natural beauty of the wood.

Some furniture is also deliberately aged and rustic.

Wood veneers also allow distinctive patterns to be created on some surfaces, such as table tops and drawer fronts by the way slivers are arranged.

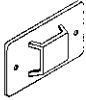
All timber and veneer surfaces will change colour and mellow over time. New furniture will initially vary in shade from items that have been previously purchased.

Fittings and parts checklist

Item	Description	Qty.	Item	Description	Qty.
A	Mounting plate 	x 2	C	Flat cross head screw Ø4 x 15mm 	x 2
B	Nylon strap 	x 1	D	Flat cross head screw Ø4 x 25mm 	x 2

TANDEM RUNNER ADJUSTMENT INSTRUCTION

REMOVE

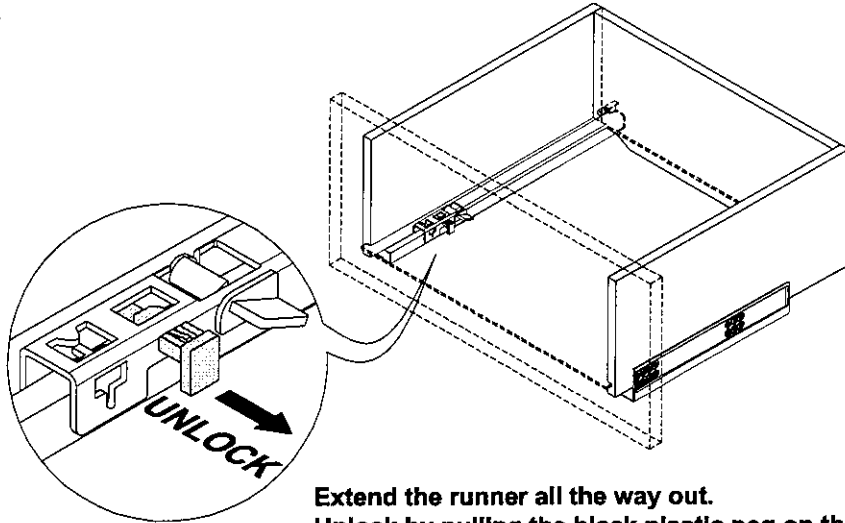

Extend the runner all the way out.
Unlock by pulling the black plastic peg on the runner out.

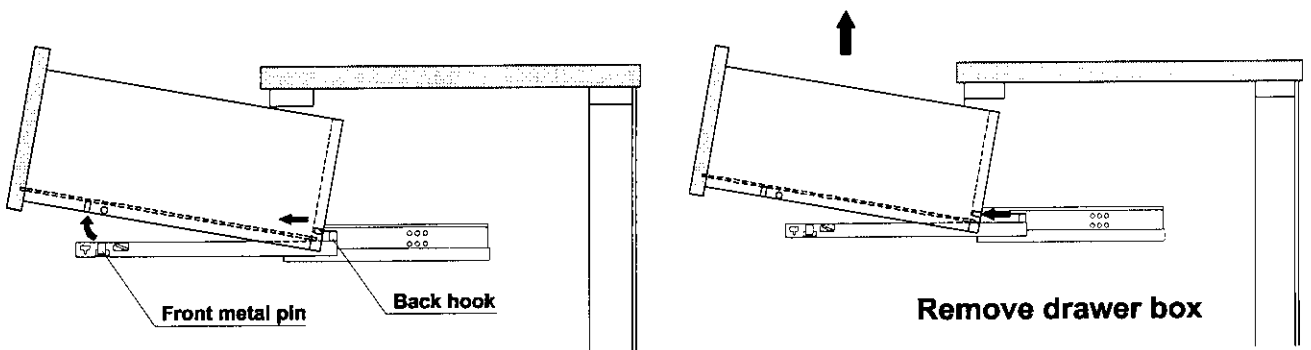

Hold runners with both of your hands.
Carefully lift the drawer front up from the front metal pin, then slide forward to remove from back hooks.

VERTICAL ADJUSTMENT (± 2.5 mm)

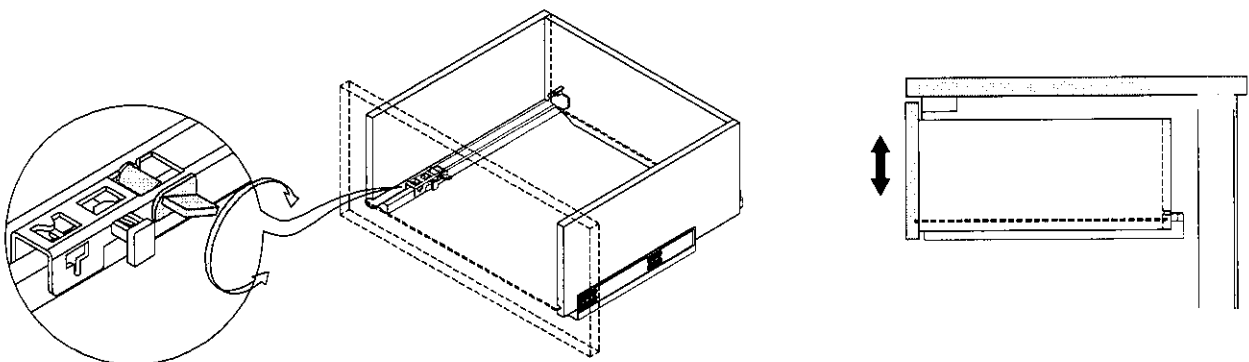

TANDEM RUNNER ADJUSTMENT INSTRUCTION

ASSEMBLE

Back hook

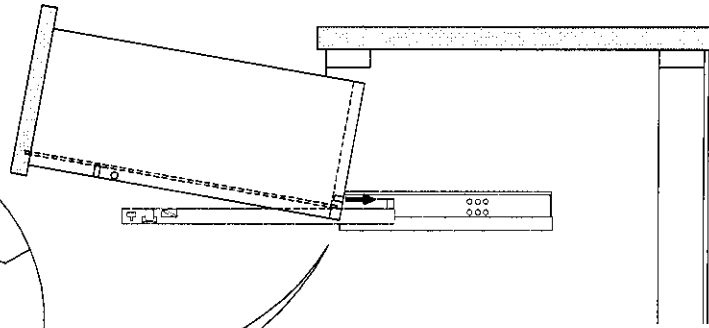
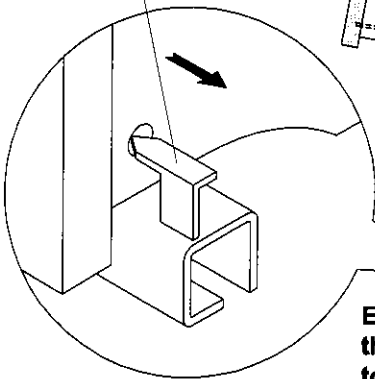

Extend the runner all the way out. Put the drawer onto them then hold both the runners with your hands, lift the drawer up with your thumbs and push to hook the drawer at the end of the runner.

Hole / Front metal pin

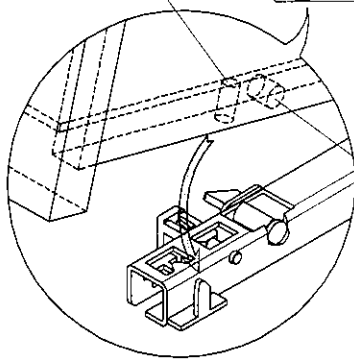

Hole / plastic peg

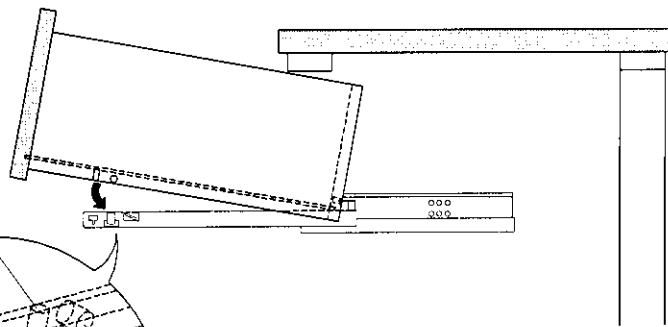

Once the back hook is connected gently lower the drawer onto the front metal pin.

Black plastic peg

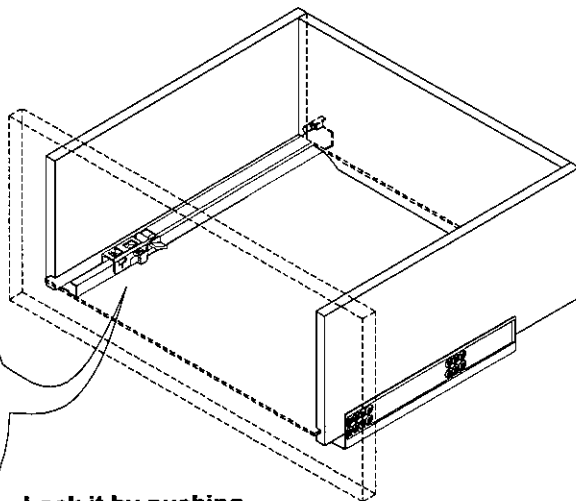
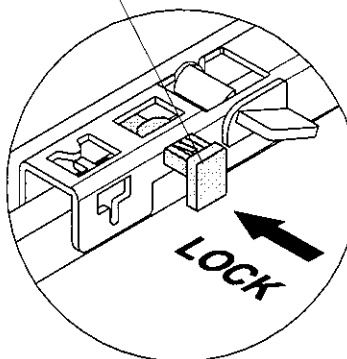

Lock it by pushing the black plastic peg on the runner in.

TIP KIT INSTRUCTIONS

Notice:

Notice: To prevent injury and property damage from unexpected tipping of furniture, we highly recommend installation of the anti-tip kit included with this product.

Attaching furniture to wall with anti-tip kits

1. Determine where the piece is to be placed and mark location on the wall for the mounting bracket screw holes. They should be placed approximately 1" below the top on the back of the piece of furniture.
2. Attach the mounting bracket vertically to the wall by inserting the long screws provided through the holes in the bracket and tightening securely using screwdriver. Screws must penetrate wall studs for proper installation.
3. Next using the short screws attach the 2nd bracket to the back of the piece of furniture's top.
4. Lace the nylon strap down through the brackets. Slide the thin end of the strap through the receiving end on the nylon strap. Pull to tighten the piece of furniture snug against wall.

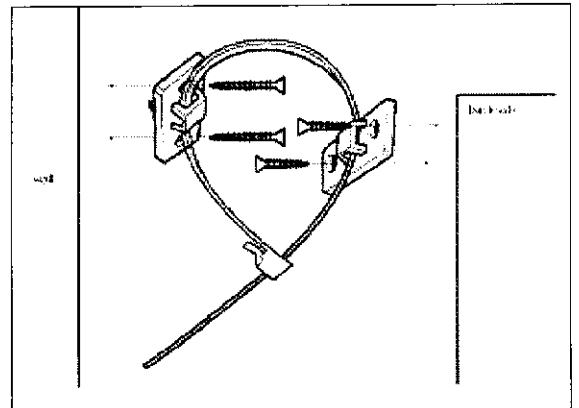
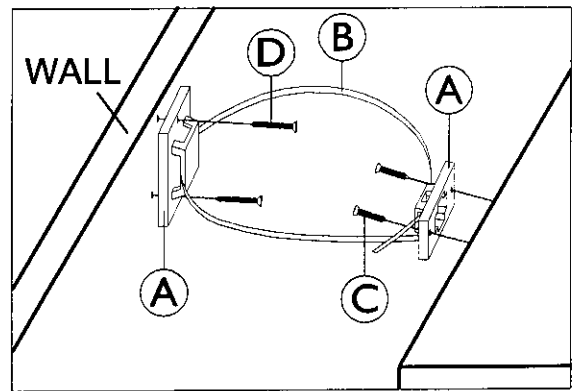
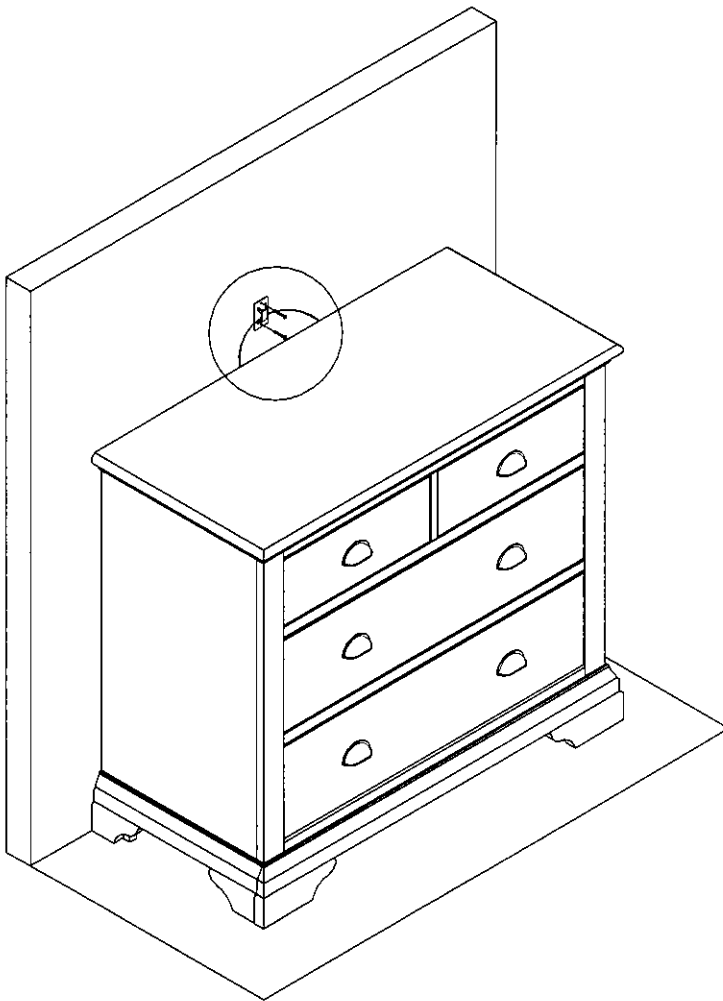

CARE INSTRUCTIONS:

1. Hardware may loosen overtime. Periodically check that all connections are tight.
2. Wipe with a soft, dry cloth. To protect finish, avoid the use of chemicals and household cleaners.

How to care for your wood furniture

Dust with a clean, damp, lint free cloth. Frequent dusting will remove abrasive build up, which can damage the finish over time.

Do not use a very wet cloth or allow any liquid to contact with the veneers for a long period of time as this can permanently damage the surface. Wipe up spills immediately.

Do not use any abrasive cleaner or harsh detergent as this can damage the surface of the furniture.

Spray polishes are best avoided as they contain silicones which may spoil the furniture's surface when building up over time.

Make sure all surfaces are protected from heat and liquids by mats and coasters.

Ensure that a mat or pad is placed under paper when you are writing on the furniture surface.

Do not place rubber or plastic materials on the wood finish as chemicals within may react with the finish if left in contact for an extended period of time.

Our furniture will endure most temperatures in the home but it is best to avoid placing furniture next to heat sources such as radiators or fires. Be particularly careful with solid wood as the lack of humidity caused by home heating can cause damage such as warping, cracking or splitting.

Excessive exposure to sunlight can cause fading of your furniture.

Safety Instructions:

Never drag furniture when moving it. Always lift it.

Periodically check all fixings to ensure none have come loose. Re-tighten when necessary.

Please take care when handling or moving the furniture as careless handling may cause damage or injury.

Furniture can be dangerous if incorrectly assembled. Assembly should be carried out by a competent person.

No liability will be accepted for damage or injury caused by incorrectly installed or assembled furniture.

Heavy item warning:

It is recommended to seek assistance when moving a heavy object. Take care when lifting to avoid personal injury and (or) damage to the product.

It is recommended that before moving a heavy object to a new location it is completely dis-assembled to avoid personal injury or damage to the furniture. Please be careful to retain all fittings when doing this.

PLEASE KEEP THESE INSTRUCTIONS FOR FUTURE REFERENCE