

# DINING CHAIR

Thank you for purchasing this product. Please read the instructions carefully before use to ensure safe and satisfactory operation of this product.

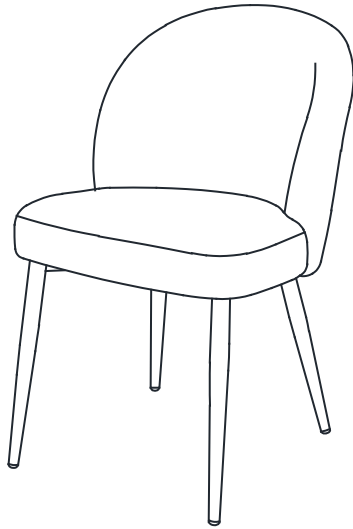

## Pre-assembly preparation

Please ensure instructions are read in full before attempting to assemble this product.

### Assembly time

1 Person



15 minutes



### Tools Needed (Included)

Allen Key # 4



Please check the pack contents before attempting to assemble this product. A full checklist of components is given in this leaflet. If any components are missing please contact the retailer from whom you bought this product.

All assembly should be performed on flat, stable, clean and soft surface.

This product is **HEAVY**, it should be assembled as near as possible to the point of use. **TAKE CARE WHEN LIFTING** to avoid personal injury and (or) damage to the product.

The fitting pack contains **SMALL ITEMS** which should be **KEPT AWAY FROM YOUNG CHILDREN**

**IMPORTANT:** Retain these instructions for future reference.

Stock Code: H2123-09-XXX





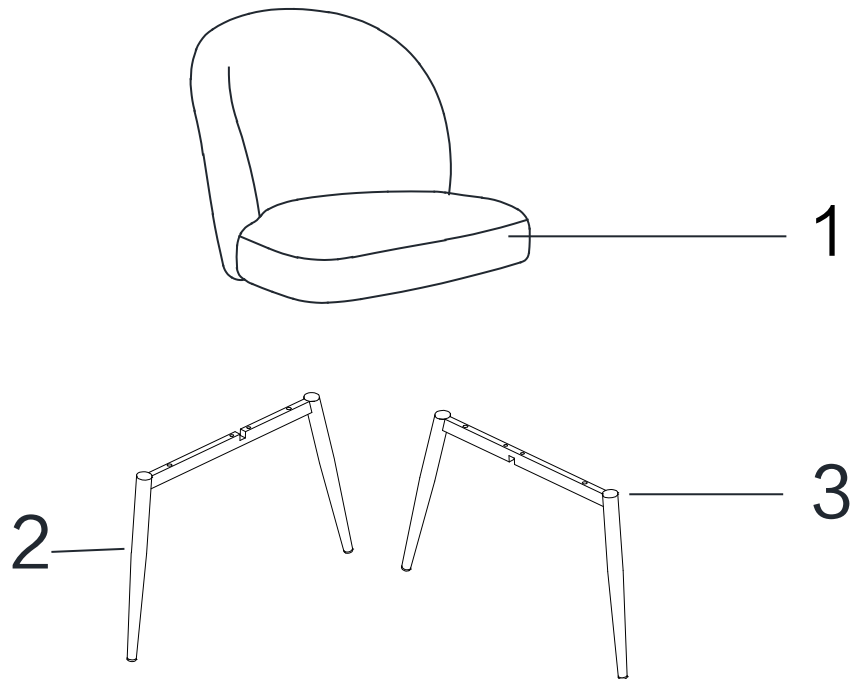

Batch: POR177007/8

Page 1 of 6

# Fittings and Parts Checklist





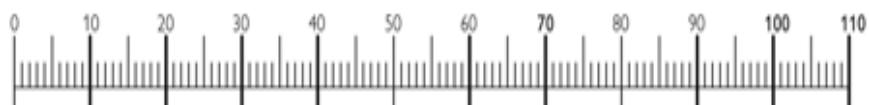

Item	Description	Qty	Item	Description	Qty
1	Back of Chair	x 1	2	Chair Leg	x 1
3	Swivel Plate	x 1			

Item	Description	Qty	Item	Description	Qty
A	Bolt M6 x 40mm 	x 4	B	Bolt M6 x 50mm 	x 4
C	Washer 6 x 16mm 	x 8	D	Cross without thread 	x 1
E	Cross with thread 	x 1	F	Allen Key 4# 	x 1



# Step by Step Assembly Instructions

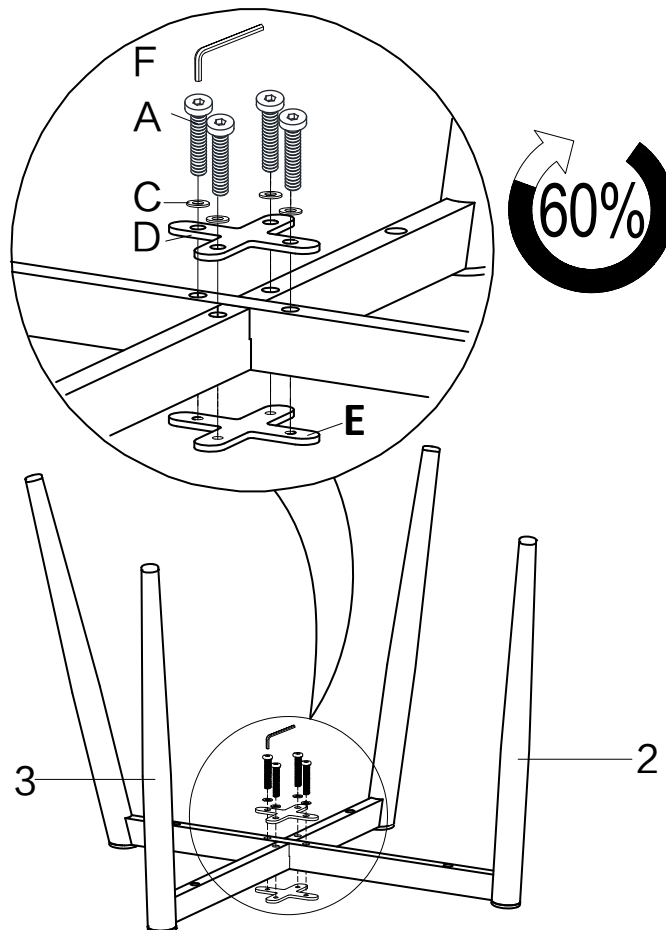
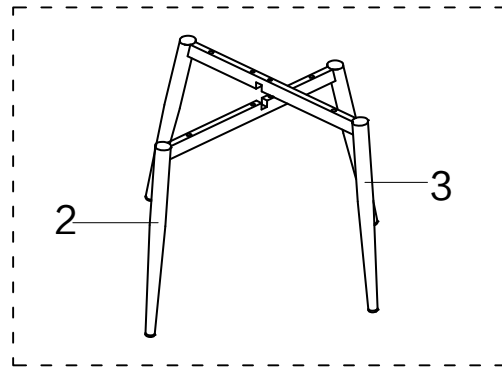

Step 1

Ax4	Cx4	Dx1	Ex1	Fx1
				
M6x40mm	6x16mm			4#



# Step by Step Assembly Instructions

Step 2

<b>Bx4</b>  M6x50mm	<b>Cx4</b>  6x16mm	<b>Fx1</b>  4#
--	---	---

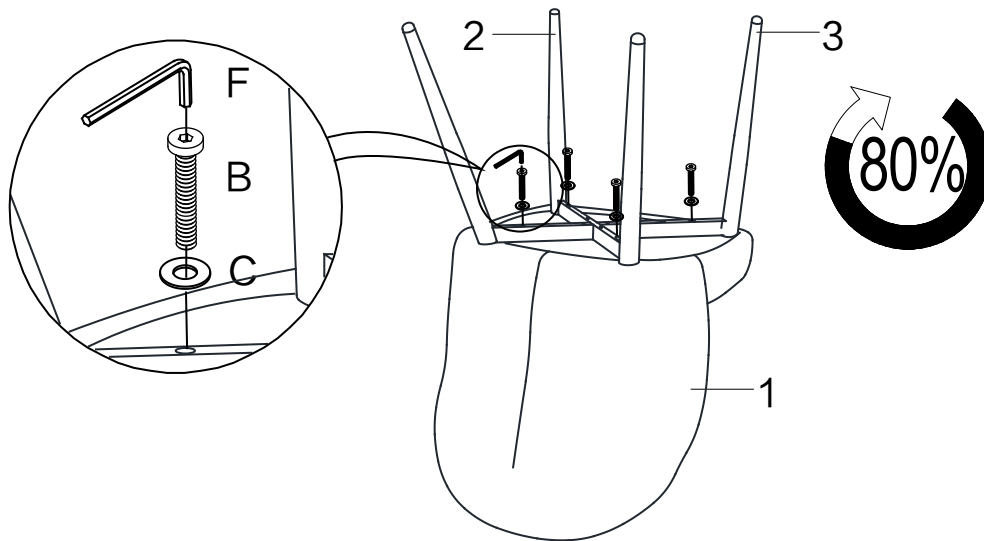

Step 3

<b>Fx1</b>  4#
---

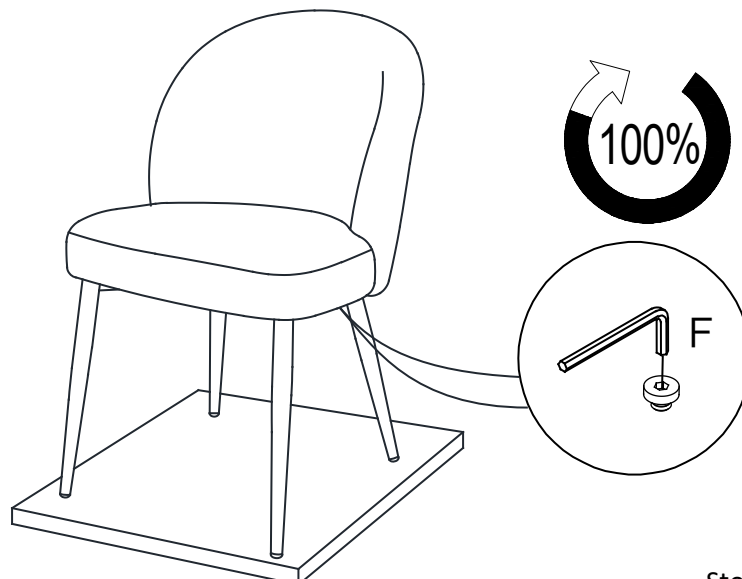

## **CARE & MAINTENANCE GUIDE**

Proper care will help preserve the beauty, durability, and function of your furniture. Please follow the guidance below, for each specific material type used in your furniture.

---

### **How to Care for Your Wood Furniture**

#### **Routine Cleaning**

- Dust regularly with a clean, dry, lint-free cloth.
- Wipe spills immediately to prevent staining or warping.
- Avoid using silicone-based polishes or abrasive cleaners, as these may degrade the finish over time.

#### **Handling & Protection**

- Always use coasters, placemats, and protective pads when placing hot or wet items on wooden surfaces.
- Place a mat or pad under paper when writing.
- Avoid placing wooden furniture near heat sources such as radiators or fires.

#### **Environmental Conditions**

- Solid wood is sensitive to temperature and humidity changes. Prolonged exposure to dry air may cause cracking or warping.
- 

### **How to Care for Your Glass Furniture**

#### **Routine Cleaning**

- Clean with a standard glass cleaner or warm soapy water.
- Use a soft cloth and avoid anything abrasive.

#### **Handling & Safety**

- Never strike or drop heavy items on the surface.
  - Use protective pads under decorative items.
- 

### **How to Care for Your Melamine Furniture**

#### **Routine Cleaning**

- Wipe with a slightly moistened cloth or sponge.
  - For dirtier surfaces, use a mild cleaning agent or diluted soap solution.
  - Dry thoroughly after cleaning.
- 

### **How to Care for Your Metal Furniture**

#### **Routine Cleaning**

- Dust frequently with a soft, dry cloth.
- For tougher marks, use a damp cloth with mild soap. Dry thoroughly.

#### **Do Not Use**

- Abrasive cleaners or scourers, as they will scratch and damage the protective lacquer.
- Cleaners containing chlorine or bleach.

---

## **How to Care for Your Upholstered Furniture**

### **Routine Cleaning**

- Vacuum or lightly brush regularly to remove dust and dirt.
- Rub very gently to avoid changing the fabric colour.

### **Avoid**

- Prolonged exposure to direct sunlight, which may cause fading.
- Placement near heat sources (e.g., radiators or open flames).

### **Spills**

- Act quickly. Blot excess liquid using a white paper towel.
- Dab gently with a clean towel. Avoid soaking the material.

---

## **How to Care for Your Sintered Stone Furniture**

### **Routine Cleaning**

- Dust regularly with a clean, lint-free cloth.
- Use a soft cloth dampened with warm water and a mild, non-abrasive detergent.
- Dry immediately to avoid residue or water spots.

### **Avoid**

- Abrasive cleaners or harsh chemicals.
- Silicone-based polishes that may leave a film.

### **Spills & Stains**

- Wipe up all spills promptly.
- For sticky residue, use diluted soapy water and a clean sponge. Rinse and dry thoroughly.
- Avoid contact with nail polish remover, hairspray, perfume, or any solvent-based product.

### **Handling**

- Do not stand or place excessive force on the stone surface.
- Always use coasters and placemats.

---

## **Moving & Placement of Furniture**

- Always lift furniture—never drag it.
- Protect corners and surfaces during handling.
- Use help when moving heavy items.
- Ensure furniture is placed on a level surface for optimal performance.

---

## **Repair & Damage**

If your furniture becomes scratched, dented, or chipped, many issues can be repaired by a qualified technician. Please contact your retailer for assistance or service recommendations.

---

## **Final Care Tips**

- Periodically check all fixings to ensure they are secure. Retighten if needed.
- Follow the specific guidance per material to avoid damage.
- With proper care, your furniture will offer many years of use and satisfaction.